

Linear Specification

BG4223

— ALS ECO series



【Basic Parameters】

- Material: AL6063-T5,anodizing
- Coating: Silver
- Length: 2500mm/0-2500mm customizable
(Other lengths on request)
- Application: Indoor
- Installation: Trimless recessed
- IP grade: IP20
- Certification: ROHS、 Reach
- Warranty: 5 years

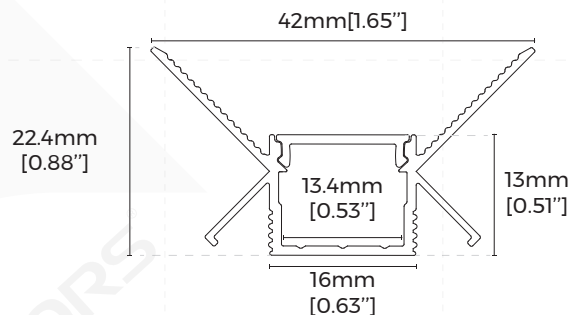
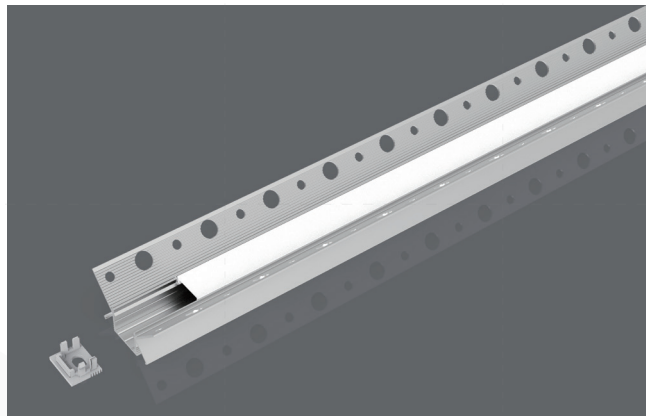

【Luminaire Parameters】

| Version | Model | Length | Input Voltage (V) | Max. Current (A/m) | Type Power (W/m) | Max. Power (W/m) | CRI | CCT | Lumen (LM/m) |
|---------|--------|--------------------|-------------------|--------------------|-------------------|--------------------|-----|-------|------------------|
| Normal | BG4223 | 1000mm (3.28ft) | 24 | 0.26 (0.09A/ft) | 6.6 (2.01W/ft) | 7.26 (2.21W/ft) | >90 | 2700K | 245 (75LM/ft) |
| | | | | | | | | 3000K | 250 (76LM/ft) |
| | | | | | | | | 4000K | 270 (82LM/ft) |
| | | | | | | | | 6000K | 270 (82LM/ft) |

Note:

1. The above parameters were tested based on 1M standard product and D6140-24V-8mm,Ra90,4000K light source;
2. luminous flux is allowed to have a $\pm 10\%$ error range;
3. The above parameters are typical values.

[Optical Parameter]

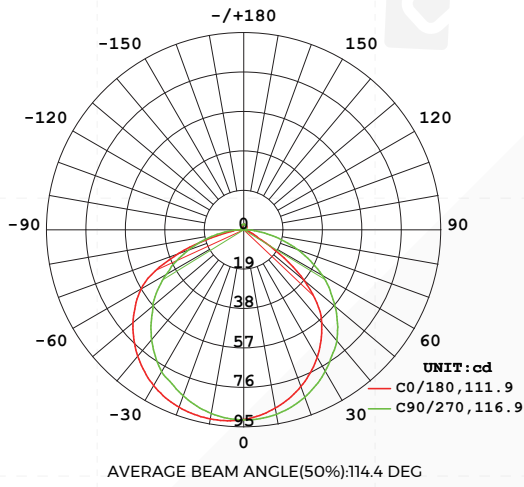

Luminous intensity distribution diagram

Flux out: 194.1 lm

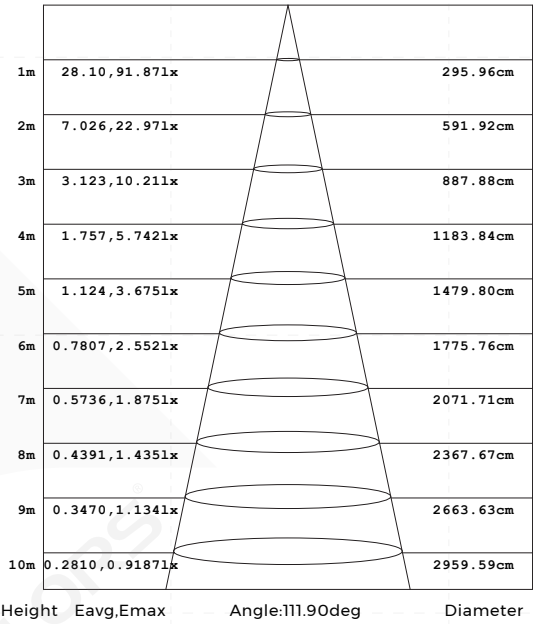

Note: The Curves indicate the illuminated area and the average, illumination when the luminaire is at different distance.

AAI Figure

[Product mechanical data]



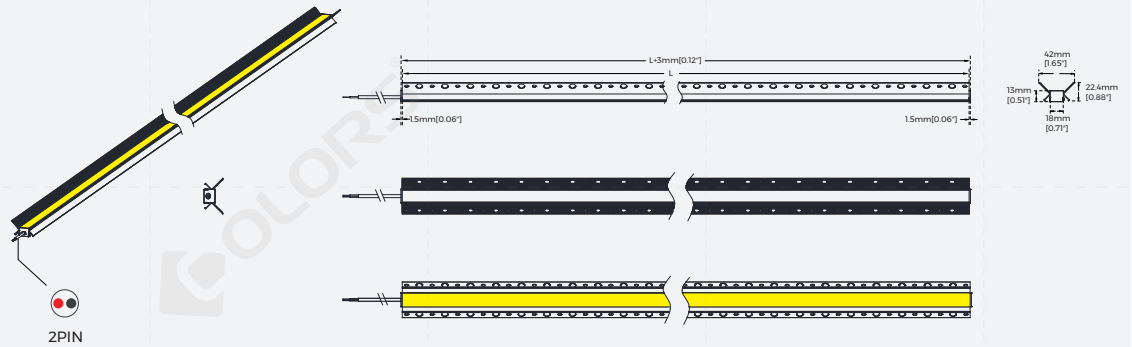

• Straight wire outlet

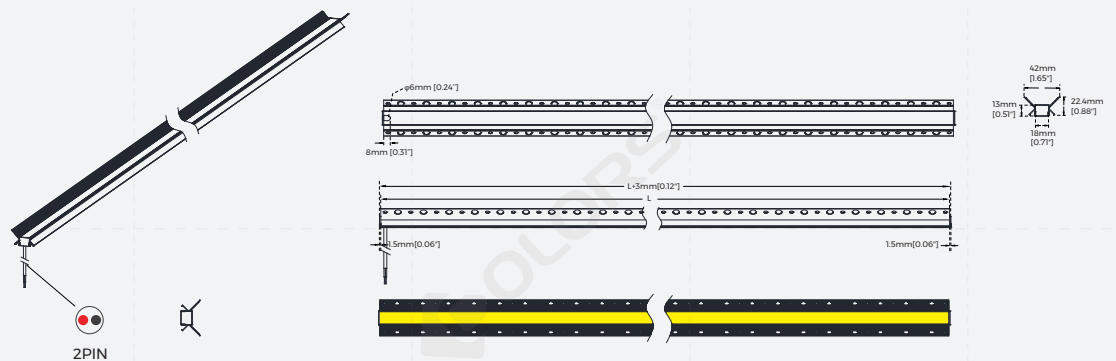

• Bottom wire outlet

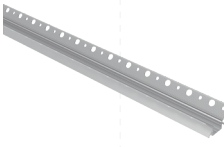
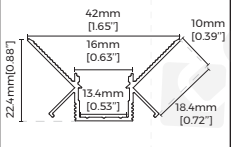

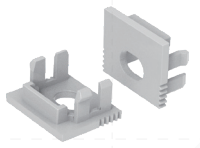
[Product Accessories Information]

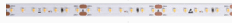
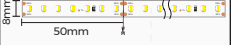
| Picture | Section size | Name | Description | Model | Note |
|---|---|----------------|---|---------------|------|
|  |  | Profile | Material: AL6063-T5 Surface processing: Anodizing/spraying Size: L2500*W42.0*H22.4mm [Inch size: L98.43"*W1.65"*H0.88"] | / | / |
|  |  | Diffuser | Material: PC Light transmittance: >60% Size: L2500*W14.5*H3.5mm [Inch size: L98.43"*W0.57"*H0.14"] PC feature: The diffuser will extend (shrink) 0.8mm/m when the temperature raises (drops) 10°C | / | / |
|  | / | End caps | Material: PC Size: L16.0*W13.0*H7.5mm [Inch size: L0.63"*W0.51"*H0.30"] Others: Holeless end caps/ End cap with hole optional | EC-BS1613 | / |
|  | / | Screw | Material: Carbon Steel Size: M3.5*40mm [Inch size: M0.14"*1.57"] | CL-01 | / |
|  |  | Flexible Strip | Material: FPC CCT: 2700/3000/4000/6000K CRI>90; Voltage: 24V; Power: 6.6W/M; Lumen: 710LM/M; Width: 8mm; Minimum cutting unit: 50mm; | D6140-24V-8mm | / |

[Packing]

| Model | Modes of packing | Quantity /box | Quantity /carton | NW /carton/(kg) | Carton (kg) | GW /carton/(kg) | Size (mm/carton) |
|------------------------|---------------------------------|----------------------|-------------------------|------------------------|--------------------|------------------------|------------------------------------|
| ALS-BG4223FDXSS2500-BC | Bulk Packaging | / | 35 | 19.25 | 1.43 | 24.00 | 2580*160*160 [101.6"*6.3"*6.3"] |
| ALS-BG4223FDXSS2500-DC | Single-Unit Inner Box Packaging | 1 | / | / | / | / | / |
| ALS-BG4223FDXSS2500-SC | Single-Unit Bag Packaging | / | 35 | 19.25 | 1.43 | 24.00 | 2580*160*160 [101.6"*6.3"*6.3"] |

[Attentions]

- 1、 Non-professionals are prohibited from installing, disassembling and repairing the product.
- 2、 Avoid scratching, distortion and irregular bending of the product during installation; otherwise it may cause irreparable damage to the product.
- 3、 Please use professional cutting tools when cutting
- 4、 Do not use any acid or alkaline adhesive to fix products
- 5、 The product is only suitable for indoor dry places, can not be used in outdoor, seaside or wet environment.
- 6、 PC features: Each 10°C rise or drop will make diffuser extend or shrink 0.8mm/m, please confirm before processing and use